

TORNOS

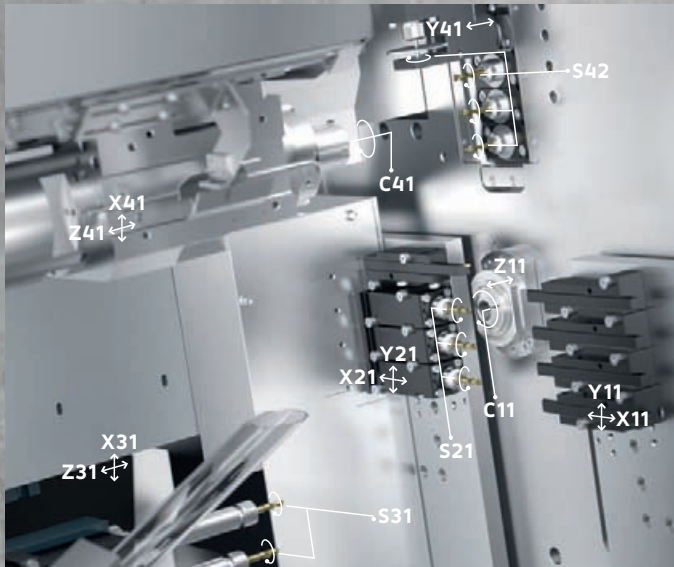

*Swiss-type
& multispindle*

PRODUCT RANGE



EvoDECO 10

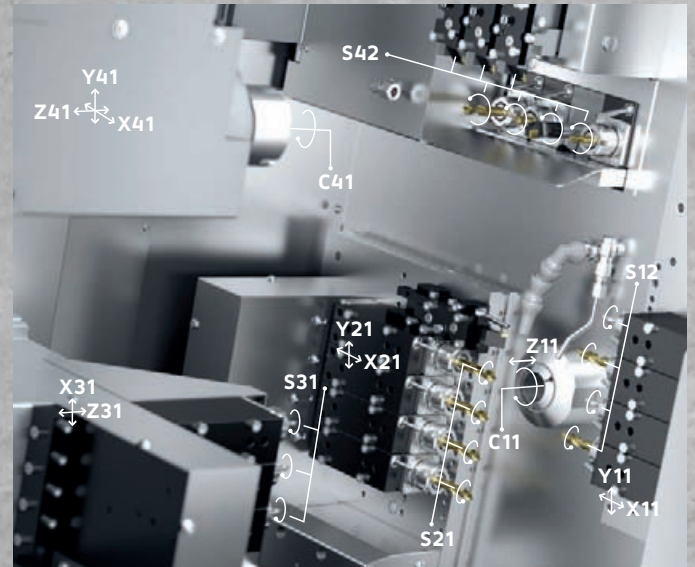

EvoDECO 20 & EvoDECO 32

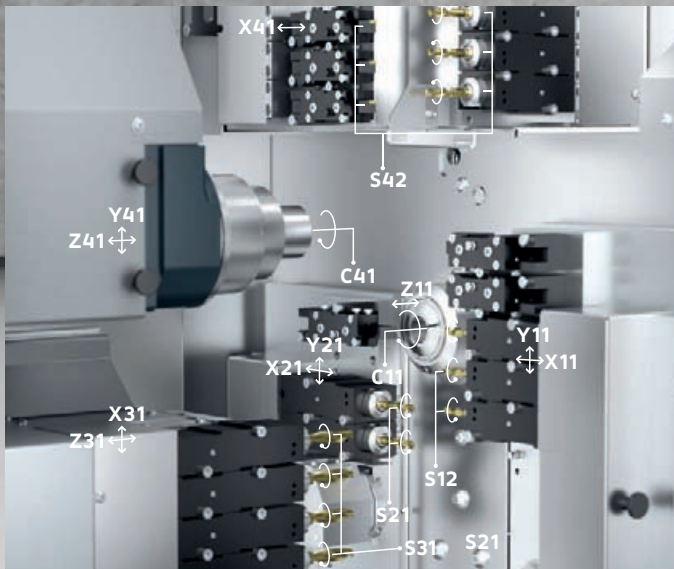

EvoDECO 16

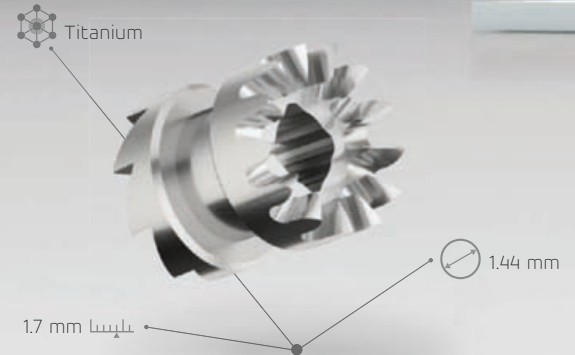

Micromechanics

Your benefits

- Identical spindle and counter spindle, with synchronous motors
- Infinite possibilities to machine advanced parts
- Highest productivity available on the market
- Completely modular machining area
- Modular/pre-adjustable tool systems and devices

Kinematics

- EvoDECO 10 and EvoDECO 16, 2 versions with 10 or 8 axes + 2 C axes
- EvoDECO 20 and EvoDECO 32, 10 linear axes + 2 C axes
- 4 independent tool systems (10 linear axes) or 3 independent tool systems (8 linear axes)
- Gear hobbing
- Polygon milling/thread whirling
- Internal and external thread whirling
- Torx milling
- Deep drilling
- Angled milling for main operations and counter operations
- B-axis in counter operation (EvoDECO 16)

EvoDECO range

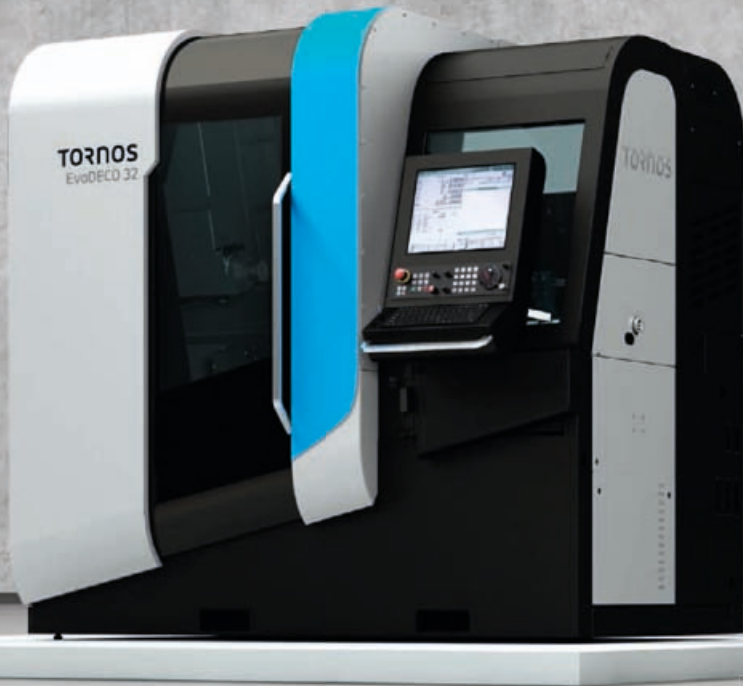

The most productive and powerful machines on the market

As the pinnacle of the Tornos range, the 10-, 16- mm, 20- and 32-mm diameter EvoDECO machines are designed for the most demanding machining operations and users. Unparalleled flexibility, efficient production the most complex workpieces and rapid setup changes are EvoDECO hallmarks.

in Brief	EvoDECO 10	EvoDECO 16	EvoDECO 20	EvoDECO 32
Max. bar capacity	10 mm	16 mm	25,4 mm	32 mm
Spindle rotation speed	14.000 rpm	12.000 rpm	10.000 rpm	8.000 rpm
Standard workpiece length with rotating guide bush	100 mm	180 mm	220 mm	260 mm
Total number of tool positions	22	27	27	27
Positions for rotating tools	10	15	17	17

SwissNano

The micro- and nano-precision specialist

Designed to meet the demand for small, very high-precision workpieces. The SwissNano's kinematics enable production of two-thirds of watch movements—from the simple to the most complex, including cutting—with excellent finishes. It's perfect for any workpiece requiring extreme quality and precision, thanks to kinematics delivering exemplary balance and thermal management for quick arrival at operating temperature.

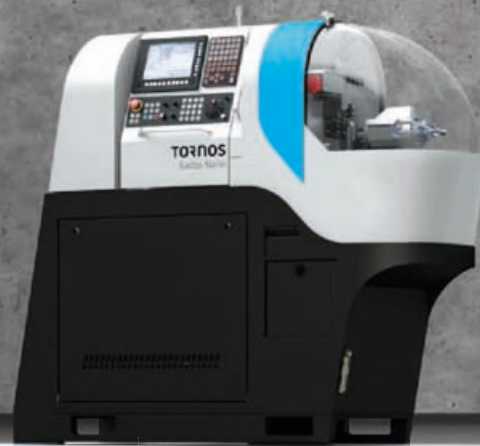

in Brief	SwissNano
Max. bar capacity	4 mm
Spindle rotation speed	16.000 rpm
Standard workpiece length with rotating guide bush	30 mm
Total number of tool positions	14
Positions for rotating tools	2

1.7 mm



Brass

1.44 mm

Micromechanics

Your benefits

- Work with or without guide bush
- Exceptional thermal stability and high precision
- Frontal access allowing complete freedom of action
- Optimized kinematics for producing watch and high precision parts
- Unique and customizable design
- The smallest footprint on the market
- Ideal replacement of cam-type lathes

Kinematics

- 6 linear axes + 1 C axis
- 2 independent tool systems
- Gear hobbing
- Thread whirling and polygon milling
- HF spindle

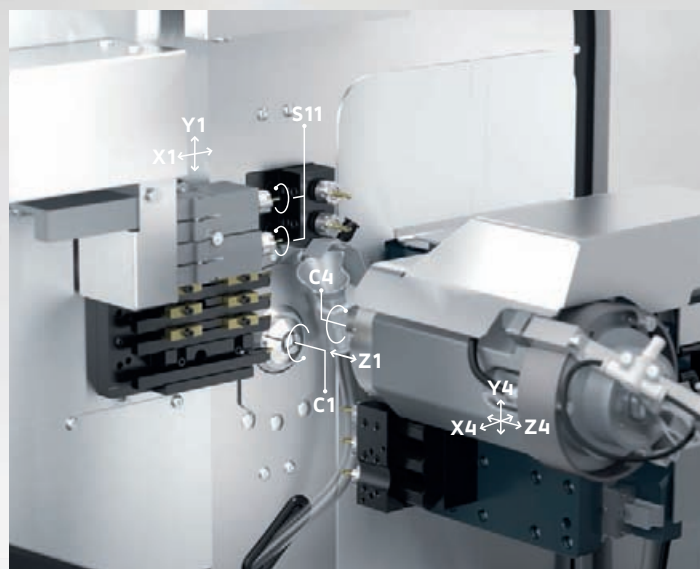

SwissNano

Swiss DT range

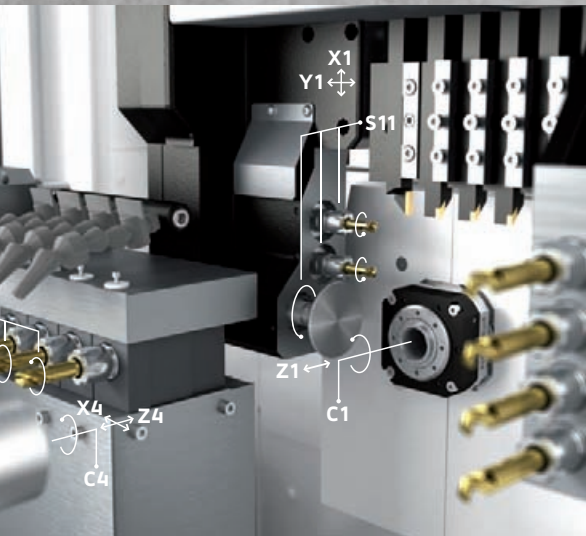

Swiss DT 13

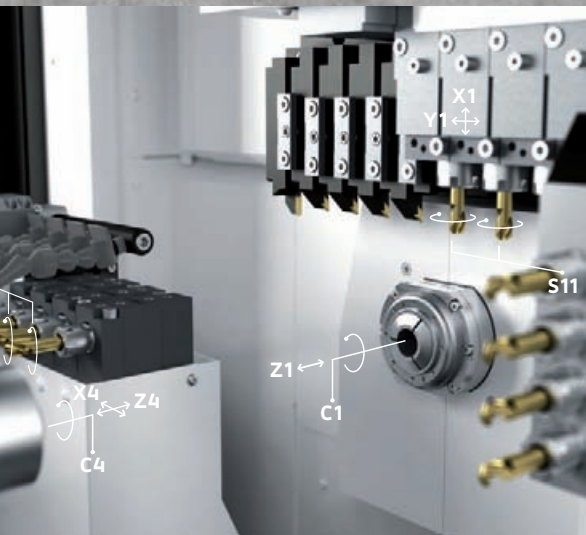

Swiss DT 26

The gateway to the Tornos world
Tornos' simple, easy-to-use Swiss DT Swiss-type lathes meet the requirements of typical long and short turned parts. Designed to machine bars up to 13 and 25.4 mm in diameter, the range enables measurable production improvements. Advanced technical features and efficient five-axis kinematics make it your ideal turning and milling solution.



in Brief	Swiss DT 13	Swiss DT 26
Max. bar capacity	13 mm	25.4 mm
Spindle rotation speed	15.000 rpm	10.000 rpm
Standard workpiece length with rotating guide bush	180 mm	195 mm
Total number of tool positions	21	22
Positions for rotating tools	7	8



Your benefits

- Liquid-cooled built-in motorized guide bush with synchronous motor
- Work with or without a guide bush
- Tools system and modular equipments
- Identical spindle and counter spindle, with asynchronous motors
- Excellent chips evacuation

Kinematics

- 5 linear axes + 2 C axes
- 2 independent tool systems
- Polygon milling
- Thread whirling
- Angled milling
- Gear hobbing

Swiss GT range

Versatility

Competitively priced automatic turning machines with a full standard equipment package. Simple and ergonomic, the Swiss GT range offers easy access to all tool positions. Its automatic lubrication unit, swarf tray and removable oil pan make it easy to maintain. Available in 32-, 25.4- and 13-mm diameters, the line will drive your successful production of long and short turned parts.



in Brief

	Swiss GT 13	Swiss GT 26
Max. bar capacity	13 mm	25.4 mm
Spindle rotation speed	15.000 rpm	10.000 rpm
Standard workpiece length with rotating guide bush	180 mm	220 mm
Total number of tool positions	30	40
Positions for rotating tools	12	14

Your benefits

- Liquid-cooled built-in motorized guide bush with synchronous motor
- Work with or without a guide bush
- Tools system and modular equipments for highly complex parts machining
- Identical spindle and counter spindle, with asynchronous motors
- Modular B axis in main operation and counter operation
- Simultaneous five-axis machining (option)

Kinematics

- 6 linear axes + 2 C axes
- 2 independent tool systems
- Polygon milling
- Thread whirling
- Angled milling
- Gear hobbing



Swiss GT 32/6	Swiss GT 26B	Swiss GT 32B
32 mm	25.4 mm	32 mm
8.000 rpm	10.000 rpm	8.000 rpm
200 mm	220 mm	200 mm
40	36	36
14	16	16

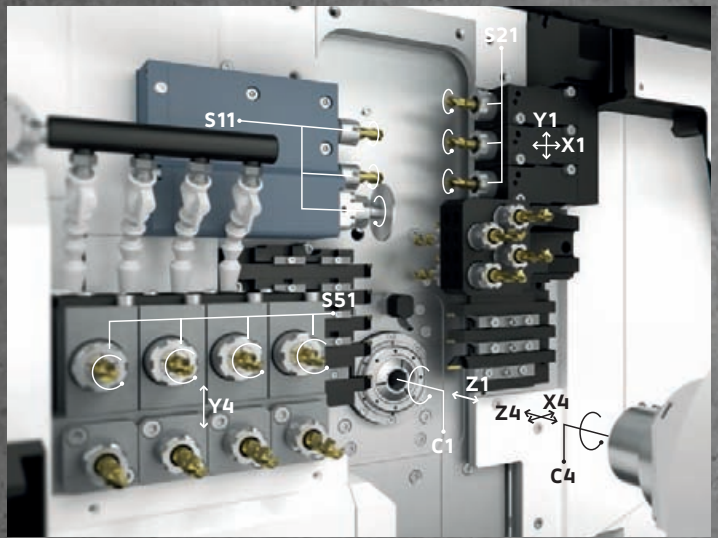
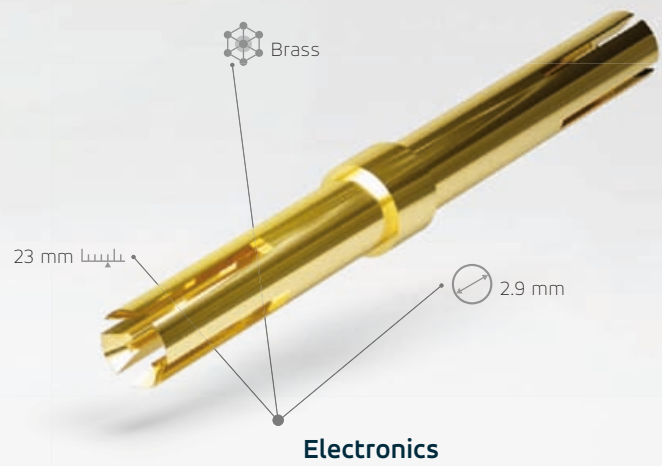

Swiss GT 13

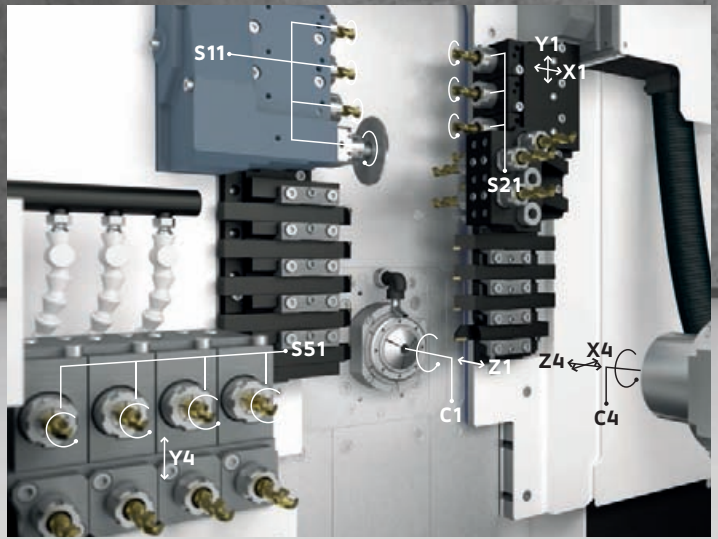

Swiss GT 26 & Swiss GT 32

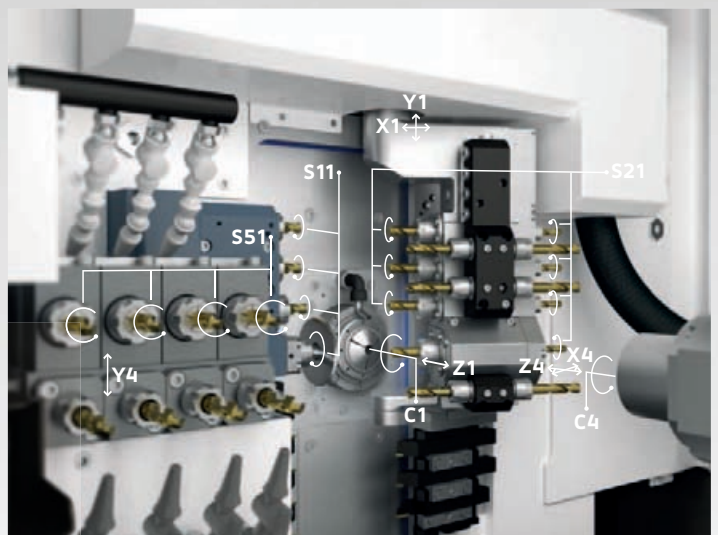

Swiss GT 26B & Swiss GT 32B

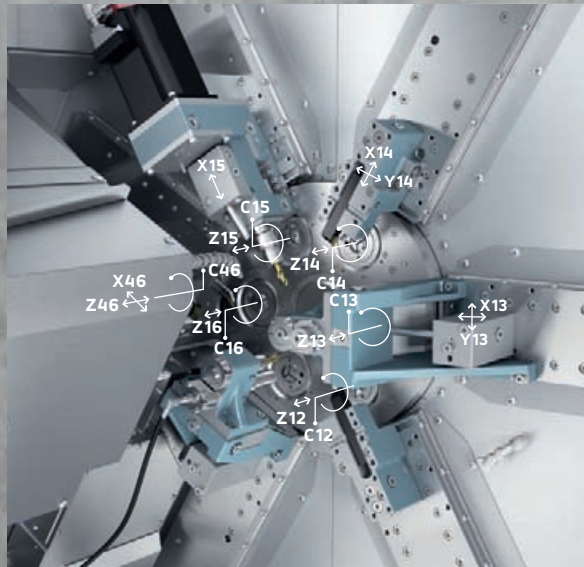

MultiSwiss 6x16

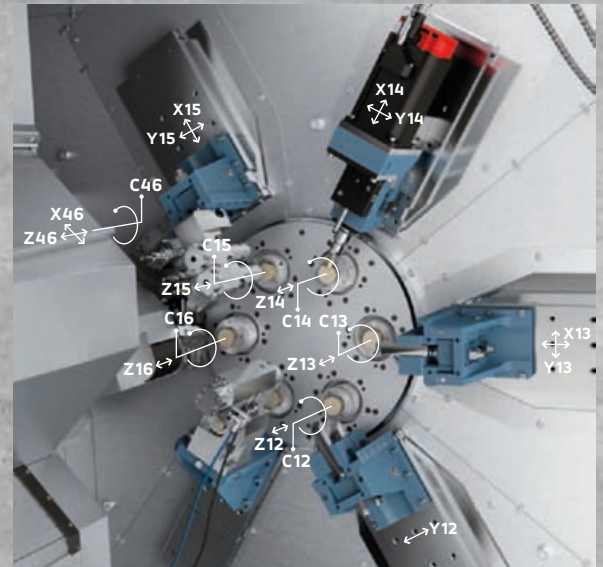

MultiSwiss 6x32

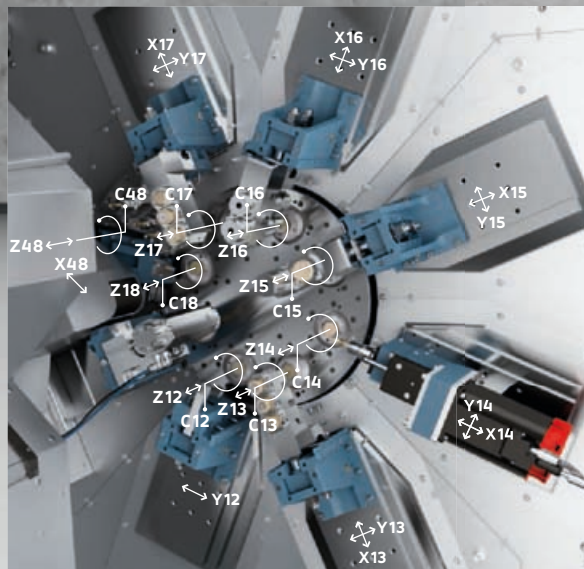

MultiSwiss 8x26

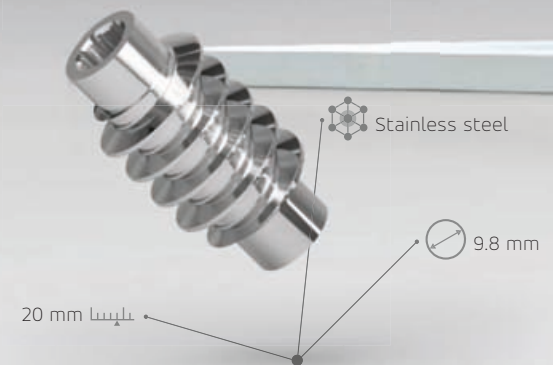

Automotive

Your benefits

- Rapid barrel indexing thanks to the torque motor
- Ultra-dynamic synchronous motorspindles
- Thermo regulated machine core
- Mobile spindles with hydrostatic bushing
- Plug & Run system for devices
- All-in-one machine concept including the bar feeder, oil tray and filtration
- Small footprint
- Easy frontal access to tools
- Chucker option
- Y axis option for greater flexibility

Kinematics

- MultiSwiss machines are all equipped with independent, mobile spindles with hydrostatic bushing. The Z axis is particularly useful when working on long parts which are hard to reach using conventional multi-spindle machines. In each machining position, the operator can tailor the speed and machining conditions as required.
- Each spindle is equipped with a C axis. The machine's hydrostatic technology offers exceptional dampening performance when machining, improving the finishes achieved while extending the tools' life span - particularly when machining hard materials. This efficient technology has a proven track record on the MultiSwiss 6x14 and Multi-Swiss 6x16 machines: tool wear is reduced by over 30%, and up to 70% in some extreme cases. This minimises machine stoppages.

MultiSwiss range



Revolutionizing the multispindle concept

Conceived as a link between multispindle and single-spindle machines, the MultiSwiss has six or eight mobile spindles using torque motor technology to index the barrel. This fast solution delivers cycle times equal to those of cam-operated multispindle turning machines.

Due to its hydrostatic technology, the MultiSwiss achieves exceptional ($Ra\ 0.15$) finishes and outstanding tool adherence even with difficult-to-machine materials. And you won't need an multispindle machine expert to program the MultiSwiss: It's easy to set up and adjust and is programmed just like six machines with three linear axes.

in Brief	MultiSwiss 6x16	MultiSwiss 8x26	MultiSwiss 6x32
Bar passage	16 mm	26 mm	32 mm
Max. part length	40 mm	65 mm	65 mm
Max. main spindle speed	8.000 rpm	8.000 rpm	8.000 rpm
Main spindle power	5.6 kW	11 kW	11 kW
Number of linear axes	14	18	14
Number of Y axis	1 (option)	3 / 6 (option)	3 (option)
Number of rotating axes (C Axis)	6 + 1 (option)	8 + 1	8 + 1
Number of cross slides in main operation	5 + 1 (cutting)	7 + 1 (cutting)	5 + 1 (cutting)
Max. number of tools	18	31	23
Max. number of tools for back operation	2	4	4
Max. number of rotating tools for back operation	1	2	2

Swiss ST 26

The high-performance Swiss-type lathe

The Swiss ST 26 is a highly competitive mid-range machine ably produces complex workpieces. Its unique kinematics allow it to perform roughing/finishing operations and use three working axes for secondary operations, and its modular tool system ensures the perfect balance of performance and efficiency. To most fully meet your needs, the Swiss ST 26 is available in three packs: Starter, Advanced, and Medical.



in Brief	Swiss ST26
Max. bar capacity	25,4 mm
Spindle rotation speed	10.000 rpm
Standard workpiece length with rotating guide bush	220 mm
Total number of tool positions	37
Positions for rotating tools	20

Your benefits

- Possibility to work with or without guide bush
- Modular tool systems and devices
- Identical spindle and counter spindle, with synchronous motors
- Available in three different packages: Starter / Advanced / Medical

Kinematics

- 7 linear axes + 2 C axes
- 2 independent tool systems
- Polygon milling
- Thread whirling
- Angled milling
- Deep drilling

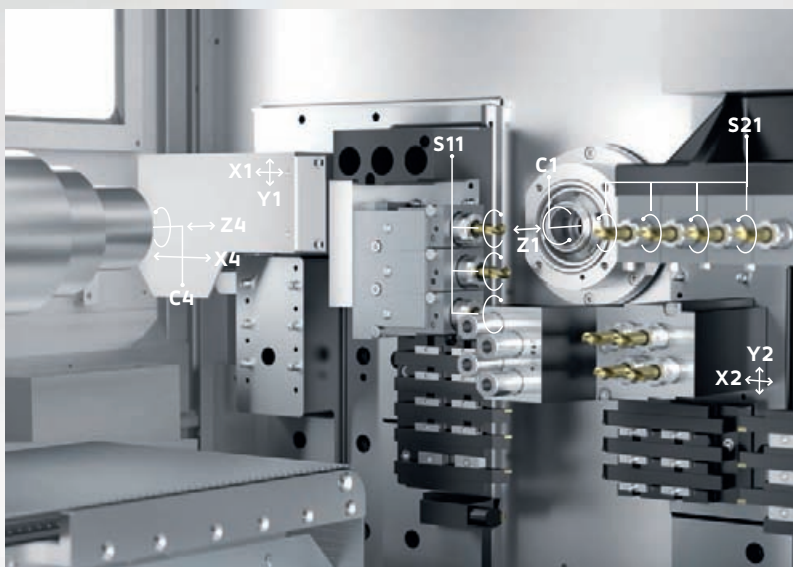

Swiss ST 26

CT 20

Powerful, robust bar turning machine

The CT 20 is designed to fulfil manufacturers' needs when creating simple to moderately complex components. The easy-to-use, productive and powerful CT 20 is the best choice for a quick return on investment.



in Brief	CT 20
Max. bar capacity	20 mm
Spindle rotation speed	8.000 rpm
Standard workpiece length with rotating guide bush	210 mm
Total number of tool positions	26
Positions for rotating tools	10

Your benefits

- Powerful spindles and drives
- Great value for price resulting in early return on investment
- Compact machine/floor space
- Ideal replacement of cam-type lathes
- Proven kinematics, excellent chip flow

Kinematics

- 5 linear axes + 2 C axes
- 2 independent tool systems

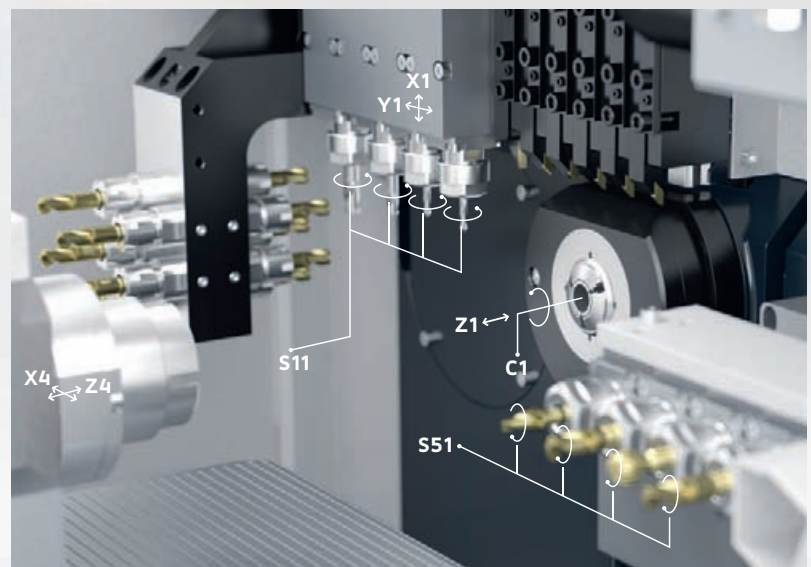

CT 20

A global footprint

Rooted in Switzerland, Tornos' global footprint keeps us close to you. Economy, flexibility and efficiency are the most important premises of the Tornos Group's production and assembly network.

Lean assembly and careful use of resources are the guiding principles behind all Tornos production planning and an integral part of the entire production process.

The same consistent quality standards are enforced at all locations around the globe. Intelligent linking of knowledge between our plants, along the commitment and know-how of our employees—enable production to begin right on time.

Wherever you are in the world, we keep you turning.

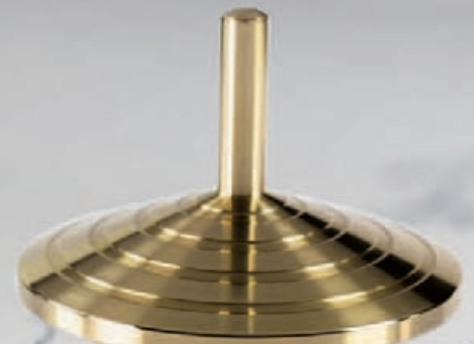

Moutier

Our Moutier site—using the latest production technologies and equipment—produces the key components of our world-renowned machines and assembles our high-end automatic turning machines and other multispindle solutions. Key components stamped “made in Switzerland” are produced in Moutier for all of our production sites.





Xi'an

Our Xi'an, China site's special testing and development center allows it to fit out machines to customer specifications. In Xian, we produce standard products delivering great value for the money on a global scale.



Taichung

In Taichung, Taiwan—a city with a long machine tool-making tradition and broad network of suppliers—Tornos produces mid-range machines. Our Taichung facility's services include customization, setup, designing models, and on-site testing of machines produces. Key components of our machines produced in Taichung are sourced from our Moutier production site.



TISIS – Communicate with your machines



Industry 4.0

Programming

Able to manage up to three channels, the ISO editor automatically synchronizes the code between the channels and uses syntax highlighting to enable value codes to be easily distinguished.

Selecting your tools

The TISIS database contains all of the tool resources; for example chisel holder plates, thread whirling tools, polygon tools or milling tools are all integrated. TISIS manages incompatibilities between the various tools and the user is guided intuitively.

Transfer

Transfer virtual programs to your bank of machines. Modify the program on the machine and transfer it again to your computer, maintaining full traceability.

Monitoring

Monitor your machine inventory in detail. See the status of the machines in the workshop and an overview of current production; the workpiece counter, remaining production time and the name and drawing of the workpiece are available at any time.



Discover the TISIS video

Service – A continuum of expert support

Backed by both geographical proximity to customers and a keen understanding of their processes, applications and market challenges, our service delivers an unparalleled continuum of support: start-up assistance; expert training and coaching; free hotline; on-site operations support and preventive maintenance; original spare parts seamlessly delivered worldwide; complete overhauls to extend the longevity of Tornos machines; and a range of operations and upgrades to expand your application capabilities and profitability.

Buying a Tornos machine is much more than a business transaction. It is your investment in the future. Our team thrives worldwide on securing the predictably high production capability of products carrying the Tornos name.

Situated close to you, as demonstrated by the 14 service centers strategically located across Europe, Asia, and the Americas, Tornos Service offers a full continuum of authoritative support for you and your Tornos machines, and encompasses the innovation, reliability and attention to detail expected of a premier Swiss brand. And it is all backed by a 100-year legacy of expertise and in-depth understanding of customers' processes, applications and challenges across a wide range of industrial segments, including automotive, medical & dental, electronics and connections, and micromechanics.

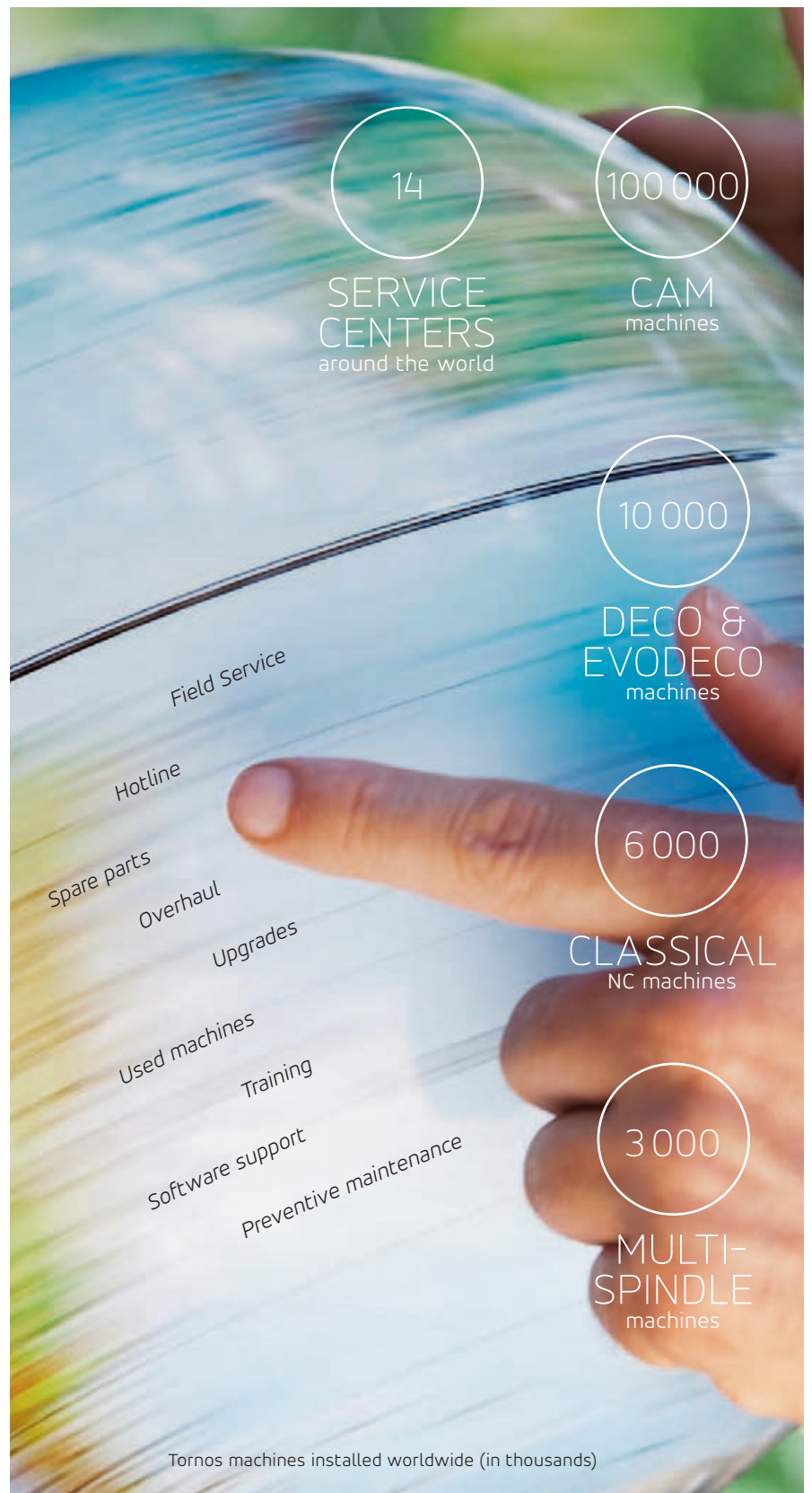

Discover
Tornos Service

We keep you turning

TORNOS LTD

Rue Industrielle 111
P.O. Box 960
2740 Moutier / Switzerland
T +41 (0)32 494 44 44
F +41 (0)32 494 44 03
contact@tornos.com

Tornos
throughout
the world

